



# ACO Packaging Ltd

SUPPLIERS OF NEW & USED BOTTLING MACHINERY FOR OVER 40 YEARS

14, Crane Mead Business Park, Ware, Herts, SG12 9PZ, England  
Tel: 01920 484050 Fax: 01920 484050 E-mail: info@acosales.co.uk Web site: www.acosales.co.uk

**Make :** ACO  
**Type :** P2-1  
**Model :** Automatic monobloc twin head filler/capper  
**Year :** NEW  
**Origin :** UK & EU

## MONOBLOC FILLING AND CAPPING MACHINE

Project description:

PRODUCT: e-liquids  
CONTAINERS: 10ml round plastic bottles  
CLOSURES: Plastic pre-threaded screw cap (1 size)  
PRODUCTION REQUIRED: maximum production 40 Bpm max

The machine is suitable for filling glass or plastic bottles with liquid / semiliquid products by means of volumetric piston filling with a 5-38 ml dosing range and for applying and closing 1 size of plastic screw cap. The filling and capping stations are closed by a safety guard with front and back access doors. The machine is equipped with an automatic cap feeding system Ø500 with pick and place cap placement. The closure of the screw cap is performed by a magnetic clutch capping head with adjustable torque.

TECHNICAL FEATURES:

- Direction: Left to right
- Mains Power req: 440v 3ph 50hz 1.1kw
- Compressed air req: 200 lpm at 6 bar
- Output: Upto 40 Bpm max
- Machine Dimensions: 1360 x 1360 x 2100mmH + cap sorter + filling system
- Stainless steel base mounted on adjustable floor levellers for easy alignment
- Bearing frame and all surface components manufactured in AISI 304 stainless steel
- Manual height adjustment
- Speed variation for machine, head speed and cap hopper
- Automatic start photocell
- Automatic stop photocell in case conveyor is full at the exit
- Adjustable dosing valves support
- Volumetric filling unit composed by:
  - Nr 2 – Dosing unit from 5 to 38cc in AISI 316 L stainless steel
  - Nr 1 – 15 litres conical hopper in AISI 316 L stainless steel
  - Tri-Clamp collars with PTFE gaskets
  - Nr 2 pneumatic 0.5" – 3 way valve
  - Nr 2 pneumatic 0.5" – 2 way non drip valve with shut off nozzle
  - Flexible hose with crimped tri-clamp connection
- All parts in contact with product are manufactured with AISI 316 L stainless steel, food grade silicon and PTFE and FKM gaskets
- Caps in chute photocell, machine will not work if there are no caps present on the chute
- Magnetic clutch capping head for screw caps

All prices are in GB Pounds Sterling and are supplied ex-VAT and ex-Works unless otherwise stated. The goods hereby supplied shall remain the property of the seller until such time as payment for the product has been made in full. Any discrepancies to be made in writing within 7 days of receipt. All goods are supplied against our standard terms and conditions which are available on request.  
E & O.E. Company Reg. GB996055 VAT Reg. No. 801981926



acosales

# ACO Packaging Ltd

SUPPLIERS OF NEW & USED BOTTLING MACHINERY FOR OVER 40 YEARS

14, Crane Mead Business Park, Ware, Herts, SG12 9PZ, England  
Tel: 01920 484050 Fax: 01920 484050 E-mail: info@acosales.co.uk Web site: www.acosales.co.uk

- Pick & place cap system
- 465mm diameter 10 pocket starwheel
- Stainless steel electrical control panel with 24 volt auxiliary commands
- SIEMENS TOUCH SCREEN
- Siemens PLC
- Motors, gears and variators: Motovario
- Pneumatic equipment: Festo
- Automatic cap feeder, chute and applicating head
- Alarm warning light and acoustics
- Safety guarding with interlock devices
- CE mark, manual and operating handbook

## OPTIONAL:

Driven conveyor 1m infeed, 1m outfeed  
Extra conveyor per metre  
Extra bottle change parts per set  
Labelling machine  
Cartoner



acosales

# ACO Packaging Ltd

SUPPLIERS OF NEW & USED BOTTLING MACHINERY FOR OVER 40 YEARS

14, Crane Mead Business Park, Ware, Herts, SG12 9PZ, England  
Tel: 01920 484050 Fax: 01920 484050 E-mail: info@acosales.co.uk Web site: www.acosales.co.uk

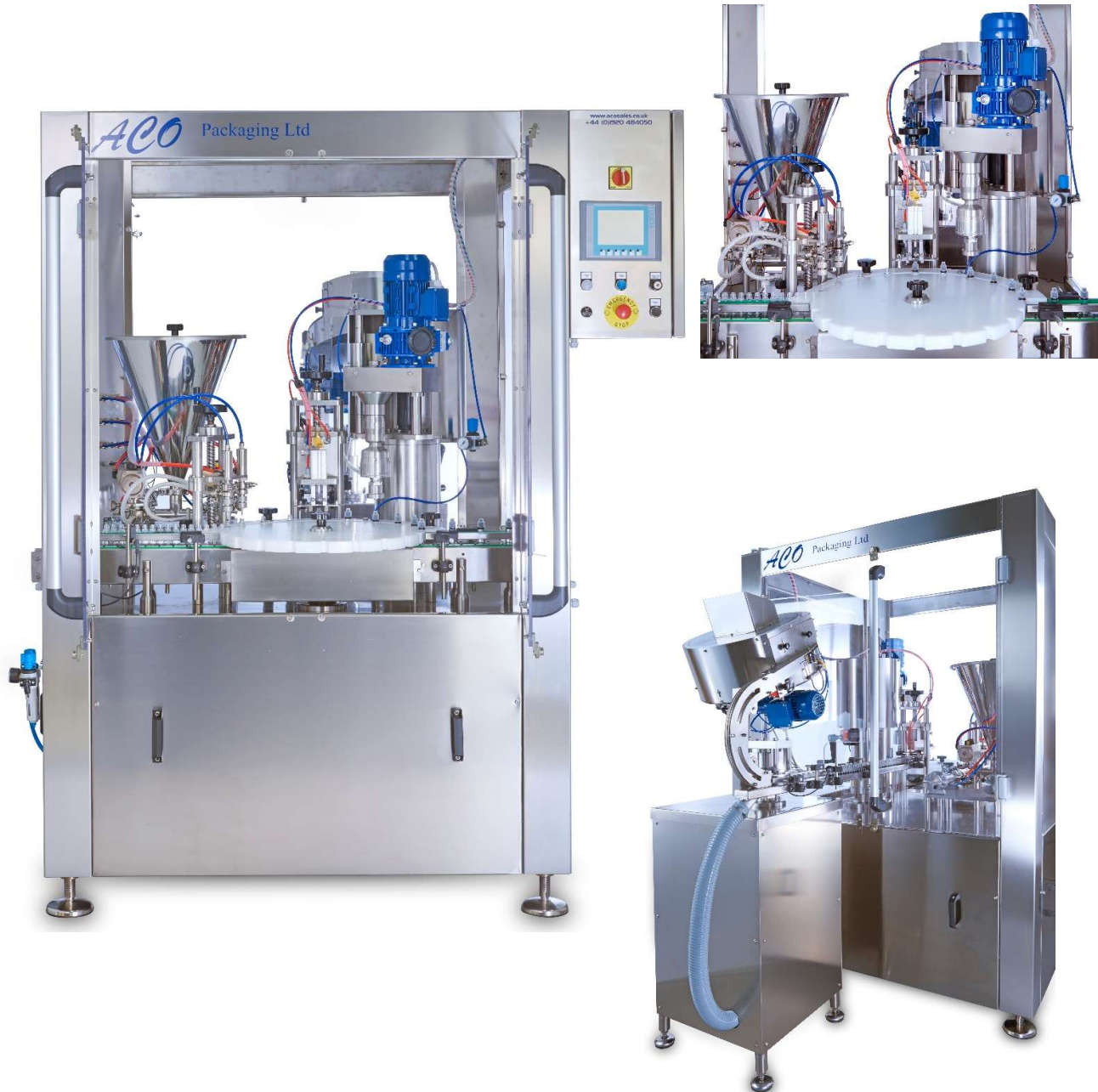

All prices are in GB Pounds Sterling and are supplied ex-VAT and ex-Works unless otherwise stated. The goods hereby supplied shall remain the property of the seller until such time as payment for the product has been made in full. Any discrepancies to be made in writing within 7 days of receipt. All goods are supplied against our standard terms and conditions which are available on request.  
E & O.E. Company Reg. GB996055 VAT Reg. No. 801981926



acosales

# ACO Packaging Ltd

SUPPLIERS OF NEW & USED BOTTLING MACHINERY FOR OVER 40 YEARS

14, Crane Mead Business Park, Ware, Herts, SG12 9PZ, England  
Tel: 01920 484050 Fax: 01920 484050 E-mail: info@acosales.co.uk Web site: www.acosales.co.uk

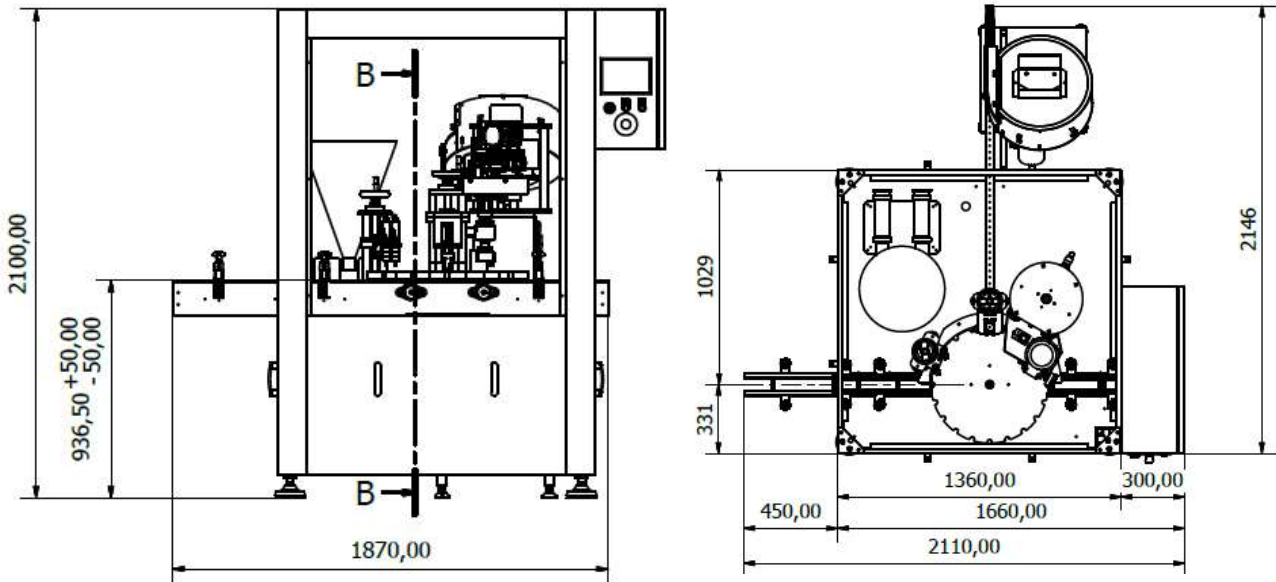

DOSING

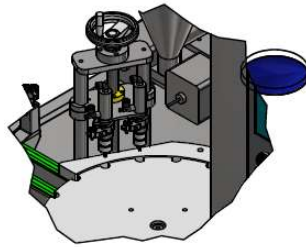

CLOSING

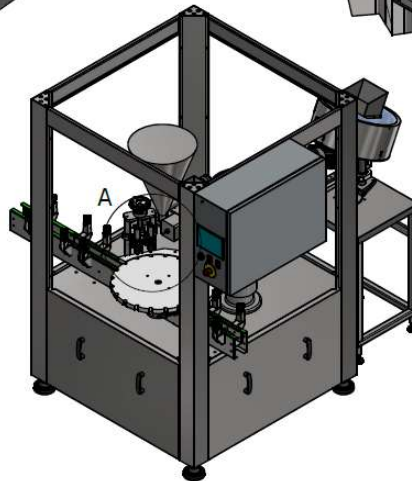
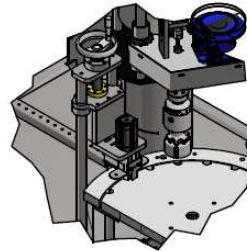

All prices are in GB Pounds Sterling and are supplied ex-VAT and ex-Works unless otherwise stated. The goods hereby supplied shall remain the property of the seller until such time as payment for the product has been made in full. Any discrepancies to be made in writing within 7 days of receipt. All goods are supplied against our standard terms and conditions which are available on request.  
E & O.E. Company Reg. GB996055 VAT Reg. No. 801981926